

# Обзор продукции Системы KG (PVC) - наружной канализации из ПВХ

## 1. Трубы KG SYSTEM

### KGEM – труба SN 4

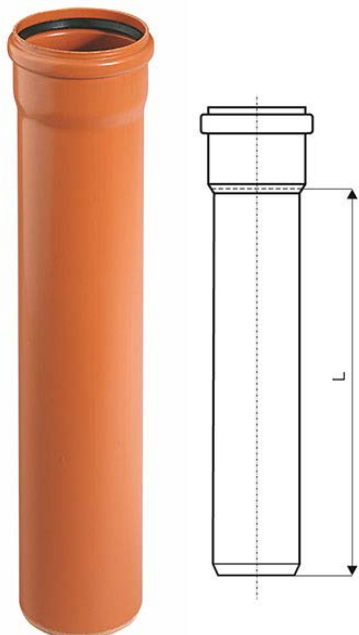

Арт.	DN	L (мм)	Упаковка
220000	110	500	1/96
220010	110	1000	1/86
220020	110	2000	1/86
<b>220030</b>	<b>110</b>	<b>3000</b>	<b>1/86</b>
220050	110	5000	1/86
221000	125	500	1/70
221010	125	1000	1/60
221020	125	2000	1/60
221050	125	5000	1/60
222000	160	500	1/40
222010	160	1000	1/40
222020	160	2000	1/40
<b>222030</b>	<b>160</b>	<b>3000</b>	<b>1/40</b>
222050	160	5000	1/40
223000	200	500	1/25
223010	200	1000	1/25
223020	200	2000	1/25
<b>223030</b>	<b>200</b>	<b>3000</b>	<b>1/25</b>
223050	200	5000	1/25
224010	250	1000	1/16
224020	250	2000	1/16
224050	250	5000	1/16
225010	315	1000	1/9
225020	315	2000	1/9
225050	315	5000	1/9
226010	400	1000	1/6
226020	400	2000	1/6
226050	400	5000	1/6

227010	500	1000	1/4
227020	500	2000	1/4
227050	500	5000	1/4

## 2. КГ - фитинги

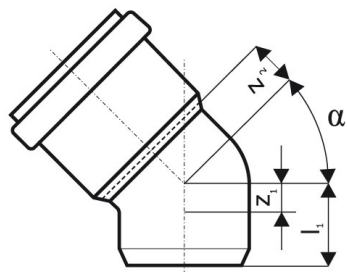

### КГВ – отвод 15°

Арт.	DN	$\alpha$	$z_1$ (мм)	$z_2$ (мм)	$I_1$ (мм)	Упаковка
220200	110	15°	9	14	69	1/300
221200	125	15°	10	15	83	1/230
222200	160	15°	13	19	94	1/110
223200	200	15°	15	23	114	1/50
224200	250	15°	19	30	153	1/24
225200	315	15°	23	38	167	1/12
226200	400	15°	29	48	184	1/8
227200	500	15°	37	59	215	1/2

### КГВ – отвод 30°

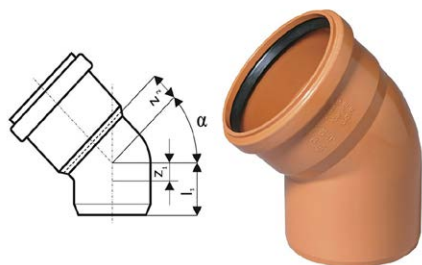

Арт.	DN	$\alpha$	$z_1$ (мм)	$z_2$ (мм)	$I_1$ (мм)	Упаковка
220210	110	30°	17	21	86	1/270
221210	125	30°	19	23	92	1/200
222210	160	30°	24	30	105	1/100
223210	200	30°	30	38	129	1/50
224210	250	30°	37	49	171	1/24
225210	315	30°	47	61	191	1/12
226210	400	30°	59	78	214	1/5
227210	500	30°	74	97	252	1/2

### КГВ – отвод 45°

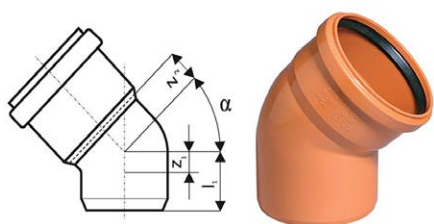

Арт.	DN	$\alpha$	$z_1$ (мм)	$z_2$ (мм)	$I_1$ (мм)	Упаковка
220220	110	45°	25	29	85	1/270
221220	125	45°	28	33	95	1/175
222220	160	45°	36	42	117	1/90
223220	200	45°	46	54	145	1/45
224220	250	45°	57	69	191	1/24



224340	250/110	45°	-37	288	206	303	1/18
224330	250/125	45°	-27	236	217	324	1/15
224320	250/160	45°	-3	254	241	372	1/14
224310	250/200	45°	24	274	268	426	1/12
224300	250/250	45°	20	265	292	485	1/8
225350	315/110	45°	-66	272	240	318	1/10
225340	315/125	45°	-56	279	251	339	1/10
225330	315/160	45°	-33	297	275	386	1/10
225320	315/200	45°	-5	318	302	441	1/8
225310	315/250	45°	28	344	335	507	1/5
225300	315/315	45°	72	378	378	594	1/4
226360	400/110	45°	-105	340	360	510	1/5
226350	400/125	45°	-94	400	400	550	1/5
226340	400/160	45°	-70	355	319	404	1/5
226330	400/200	45°	-43	375	346	458	1/5
226320	400/250	45°	-10	480	450	660	1/3
226310	400/315	45°	34	540	500	780	1/2
226300	400/400	45°	91	550	500	850	1/1
227360	500/110	45°	-150	440	435	550	1/2
227350	500/160	45°	-115	420	370	600	1/2
227340	500/200	45°	-88	470	510	650	1/2
227330	500/250	45°	-55	550	530	680	1/1
227320	500/315	45°	-11	560	583	810	1/1
227310	500/400	45°	47	580	550	840	1/1
227300	500/500	45°	114	650	680	880	1/1

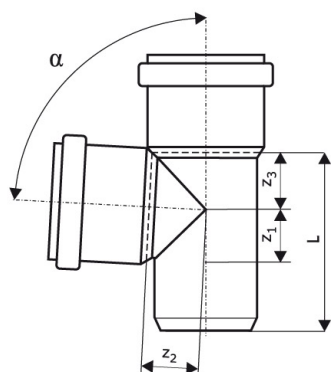

### КГЕА – тройник 87°

Арт.	DN	α	z <sub>1</sub> (мм)	z <sub>2</sub> (мм)	z <sub>3</sub> (мм)	L (мм)	Упаковка
220400	110/110	87°	59	62	62	197	1/120
221410	125/110	87°	59	70	63	204	1/100
221400	125/125	87°	66	70	70	218	1/88
222420	160/110	87°	60	87	65	225	1/60
222410	160/125	87°	67	87	72	239	1/45
222400	160/160	87°	84	89	89	273	1/45

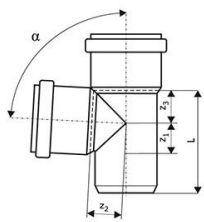

223430	200/110	87°	61	106	67	248	1/41
223420	200/125	87°	69	106	75	264	1/38
223410	200/160	87°	86	108	91	297	1/32
223400	200/200	87°	107	113	113	336	1/24
224440	250/110	87°	64	160	130	330	1/24
224430	250/125	87°	72	170	130	360	1/24
224420	250/160	87°	88	165	135	390	1/16
224410	250/200	87°	107	160	160	420	1/14
224400	250/250	87°	131	160	180	460	1/10
225450	315/110	87°	67	200	130	390	1/10
225430	315/160	87°	90	200	160	440	1/10
225420	315/200	87°	110	170	180	490	1/7
225410	315/250	87°	134	220	210	540	1/6
225400	315/315	87°	166	260	220	550	1/6
226460	400/110	87°	70	250	100	470	1/5
226440	400/160	87°	95	210	150	510	1/5
226430	400/200	87°	114	230	200	560	1/4
226420	400/250	87°	139	230	220	610	1/4
226410	400/315	87°	114	300	220	630	1/3
226400	400/400	87°	210	310	240	650	1/2
227450	500/160	87°	100	220	280	550	1/2
227430	500/250	87°	144	260	150	650	1/2
227420	500/315	87°	175	330	300	660	1/2
227410	500/400	87°	216	267	226	730	1/1
227400	500/500	87°	262	270	270	780	1/1

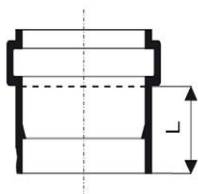

### KGAM – муфта насадная\*

Арт.	DN	L(мм)	Упаковка
220810	110	76	1/450
221810	125	82	1/350
222810	160	100	1/180
223810	200	120	1/100

\* при монтаже не используется уплотнительная манжета. Только клеевое соединение.

### KGK – крышка\*

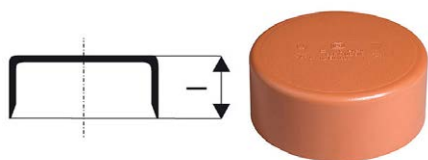

Арт.	DN	I (мм)	Упаковка
220630	110	43	10/1150
221630	125	44	10/840
222630	160	52	10/430
223630	200	64	8/224
224630	250	68	1/150
225630	315	77	1/80
226630	400	90	1/44
227630	500	118	1/19

\* на гладкий конец трубы

### KGМ – заглушка

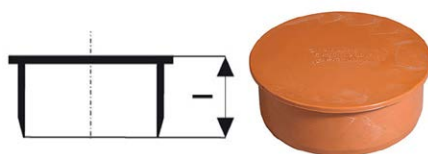

Арт.	DN	I (мм)	Упаковка
220620	110	40	10/1360
221620	125	42	10/870
222620	160	49	8/368
223620	200	65	8/224
224620	250	89	1/96
225620	315	92	1/60
226620	400	95	1/32
227620	500	98	1/14

### KGMM – муфта двойная

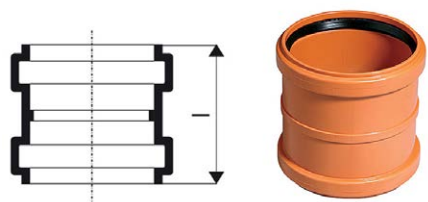

Арт.	DN	I (мм)	Упаковка
220510	110	125	1/320
221510	125	138	1/240
222510	160	172	1/110
223510	200	212	1/60
224510	250	250	1/32
225510	315	293	1/16

## KGU – муфта подвижная

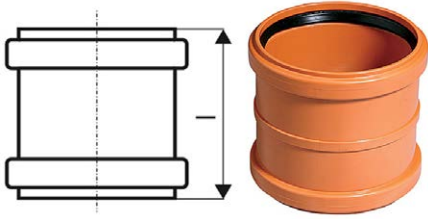

Арт.	DN	l (мм)	Упаковка
220500	110	125	1/320
221500	125	138	1/240
222500	160	172	1/110
223500	200	212	1/60
224500	250	250	1/32
225500	315	293	1/16
226500	400	324	1/8
227500	500	362	1/4

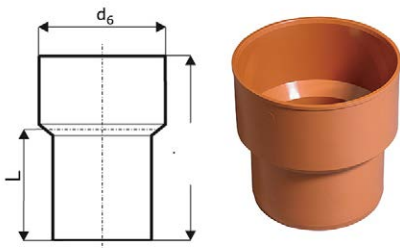

## KGUG – переход на чугунную трубу\*

Арт.	DN	d <sub>6</sub> (мм)	l (мм)	L (мм)	Упаковка
220820	110	131	133	76	1/600
221820	125	158	151	87	1/360
222820	160	185	165	98	1/216
223820	200	236	220	130	1/100

\* Для уплотнения необходимо: GA-Set, GA-манжета

## KGUS – переход на гладкий конец керамической трубы\*

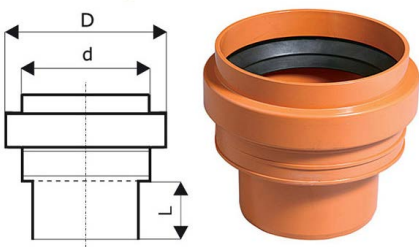

Арт.	DN	d (мм)	D (мм)	L (мм)	Упаковка
220830	110	138	156	60	1/288
221830	125	164	186	67	1/180
222830	160	194	217	81	1/100
223830	200	250	279	99	1/48
224830*	250	335	352	180	1/36
225830*	315	390	430	225	1/18

\* Фитинг из полиуретана

## KGUSM – переход на раструб керамической трубы

Арт.	DN	D (мм)	L (мм)	Упаковка
220840	110	132	70	1/455
221840	125	160	70	1/320

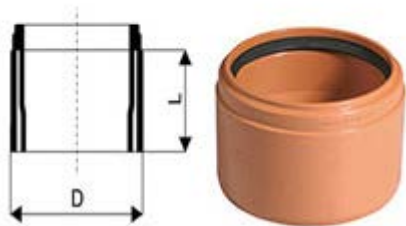

Арт.	DN	z <sub>1</sub> (мм)	L (мм)	Упаковка
222840	160	187	70	1/226
223840	200	242	70	1/120
224840	250	298	70	1/30
225840	315	354	70	1/20

### KGR – переход эксцентрический (редукция)

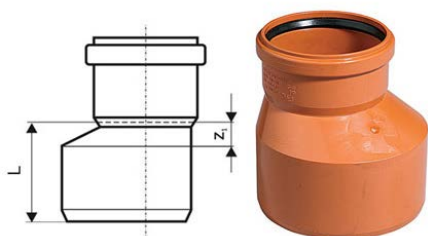

Арт.	DN	z <sub>1</sub> (мм)	L (мм)	Упаковка
221700	125/110	20	87	1/300
222700	160/110	33	134	1/250
222710	160/125	31	121,5	1/240
223700	200/160	31	130	1/130
224700	250/200	38	172	1/54
225700	315/250	50	194	1/21
226700	400/315	64	219	1/10
227700	500/400	76	254	1/2

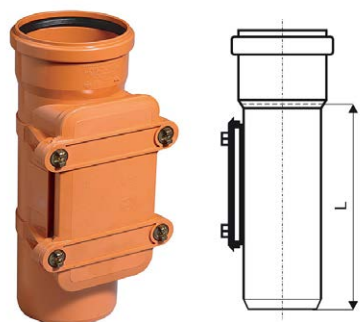

### KGRE – ревизия с прямоугольным люком

Арт.	DN	L (мм)	Упаковка
220600	110	288	1/102
221600	125	300	1/90
222600	160	360	1/44
223600	200	435	1/22

### KG – уплотнительное кольцо



Арт.	DN	Упаковка
880060	110	29
880075	125	25
880090	160	23
880100	200	20



880110	250	-
880120	315	-
880130	400	-
880140	500	-

### KG – NBR уплотнение (маслостойкое)



Арт.	DN	Упаковка
880260	110	44
880275	125	38
880290	160	34
880300	200	31
880310	250	-
880320	315	-
880330	400	-
880340	500	-



### GA-манжета для KGUG\*

Арт.	DN	Упаковка
881025	110	16

\* KGUG – переход на чугунную трубу

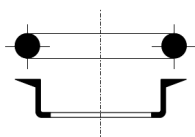

### KG – GA-Set двойное уплотнение для KGUG\*

Арт.	DN	Упаковка
881030	125	10
881040	160	15
881050	200	14

\* KGUG – переход на чугунную трубу

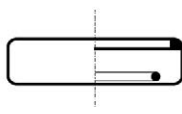

### KG – профильное уплотнение для KGUS

Арт.	DN	Упаковка
881100	110	144
881110	125	90
881120	160	50
881130	200	24

881140	250	15
881150	315	15

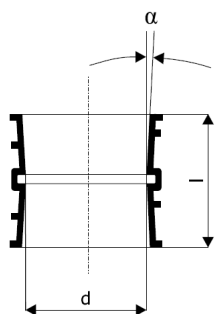

### КGF PU – гильза для прохода стен

Арт.	DN	a	d (мм)	l (мм)	Упаковка
820900	110	3°	110,4	110	1/325
821900	125	3°	125,4	110	1/270
822900	160	3°	160,5	110	1/180
823900	200	3°	200,6	110	1/114
820910	110	3°	110,4	240	1/168
821910	125	3°	125,4	240	1/135
822910	160	3°	160,5	240	1/84
823910	200	3°	200,6	240	1/45
824910	250	3°	250,8	240	1/33
825910	315	3°	316,0	240	1/18
826910	400	3°	401,2	240	1/15
827910	500	3°	501,5	240	1/12

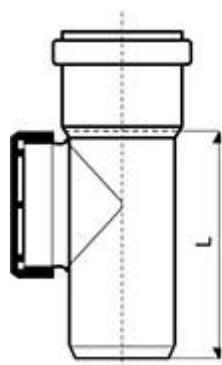

### КGRE – ревизия с круглым люком

Арт.	DN	L (мм)	Упаковка
824600	250	351	1/9
825600	315	492	1/6
826600	400	573	1/4

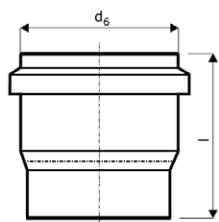

### КГ2000ВА – врезка по месту (бет. труба, колодец, септик)

Арт.	DN	l (мм)	Упаковка
877570	150	165	1/90
877670	200	197	1/40

### Клапан обратный

Арт.	DN	Упаковка
908001	50	-
908002	110	-



<b>908003</b>	<b>160</b>	<b>-</b>
---------------	------------	----------

### KG – техническая смазка



Арт.	мл	Упаковка
881800	150	50/1750
881810	250	50/1500
881820	500	24/720
881830	1000	12/360